



## Air Pollution Control Division

## Technical Services Program

### **Appendix GM9**

Standard Operating Procedure for the Remote High-Resolution Digital Camera System  
(NetCamXL 1.1.78)

Page intentionally left blank

**TABLE OF CONTENTS**

<b>1</b>	<b>Scope and Applicability</b> .....	<b>4</b>
1.1	Introduction.....	4
1.2	Method Overview .....	4
1.3	Format and Purpose .....	4
<b>2</b>	<b>Apparatus and Materials</b> .....	<b>4</b>
2.1	Monitoring Equipment.....	4
2.1.1	Instrument Shelter .....	4
2.1.2	Data Acquisition System.....	5
2.1.3	Wiring .....	5
2.1.4	Spare Parts and Incidental Supplies .....	6
<b>3</b>	<b>Calibration</b> .....	<b>6</b>
<b>4</b>	<b>Operation and Maintenance</b> .....	<b>6</b>
4.1	Routine Operation and Maintenance.....	6
<b>5</b>	<b>Troubleshooting</b> .....	<b>7</b>
<b>6</b>	<b>Data Acquisition</b> .....	<b>9</b>
<b>7</b>	<b>Works Cited</b> .....	<b>9</b>

**TABLE OF FIGURES**

Figure 1.	Enclosure.....	5
Figure 2.	Enclosure Wiring Diagram.....	6

## **1 SCOPE AND APPLICABILITY**

This Standard Operating Procedure covers use and operation of the high resolution camera located at DESCI.

### **1.1 Introduction**

The high resolution camera is intended to provide the public with a real-time view of the air quality (at least in terms of visibility) in the Denver Metro area. It is also used by forecasters within the Air Pollution Control Division (APCD) as a tool to determine trending for future air quality.

### **1.2 Method Overview**

This measurement collects high-resolution digital images of visibility conditions via a digital camera system – StarDot Technologies NetCamXL 1.1.78 herein called the camera (Stardot-Tech). The frequency and resolution of the images are variable but typically the system is operated to capture a minimum of at least one picture per minute. At any time external users can access the most recent picture taken by the camera at [www.colorado.gov/airquality/live\\_image.aspx](http://www.colorado.gov/airquality/live_image.aspx). Pictures are stored at regular intervals and are used to create time-lapsed windows media video files.

### **1.3 Format and Purpose**

The sequence of topics covered in visibility camera follows 2007 EPA guidance on preparing standard operating procedures (SOPs). This method was also written to help field operators understand why (not just how) key procedures are performed (US EPA, 2007).

## **2 APPARATUS AND MATERIALS**

### **2.1 Monitoring Equipment**

The camera consists of four major components:

- A high-resolution digital camera with zoom lens
- A modem with internet service and a dedicated static Internet Protocol address
- A power support system
- A lockable environmental enclosure

The camera requires a computer connection to view the image, make adjustment to the image quality, or capture an image for storage. The camera has limited on-board memory.

#### **2.1.1 Instrument Shelter**

The camera is housed in a Pelco EH5700 Series enclosure. Please refer to the Installation/Operation Manual. Figure 1 below shows a diagram of the shelter enclosure.

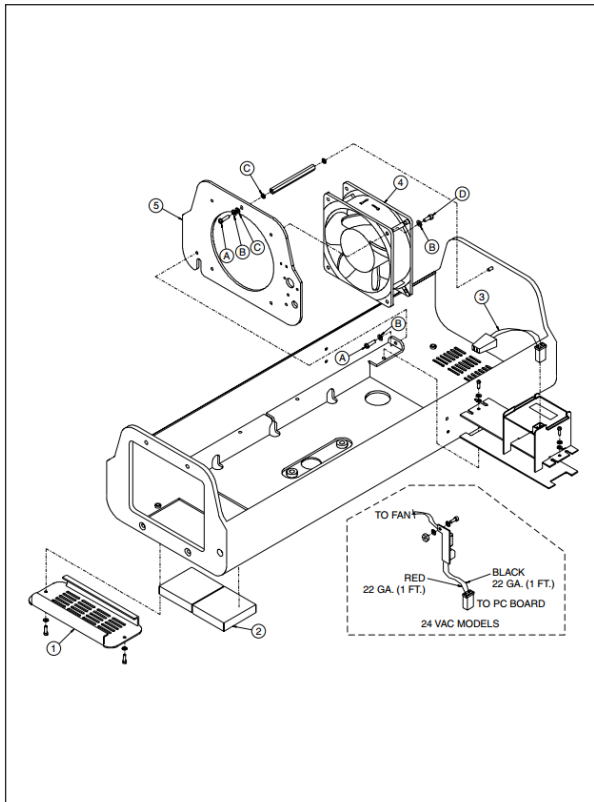

Figure 1. Enclosure

### 2.1.2 Data Acquisition System

The camera is connected directly via CAT5 or higher cable to the modem inside the building. The camera produces a picture file whenever requested via an HTTP interface. Pictures are displayed, compiled, and archived at APCD. See Section 6 for more details.

### 2.1.3 Wiring

Please refer to the StarDot support website at <http://www.stardot-tech.com/support.html> for wiring and general operation of the camera.

Please refer to the Installation/Operation Manual for the Pelco EH5700 Series enclosure for connections between the camera and the enclosure (Pelco). Figure 2 below shows a schematic for the Pelco Input Wiring.

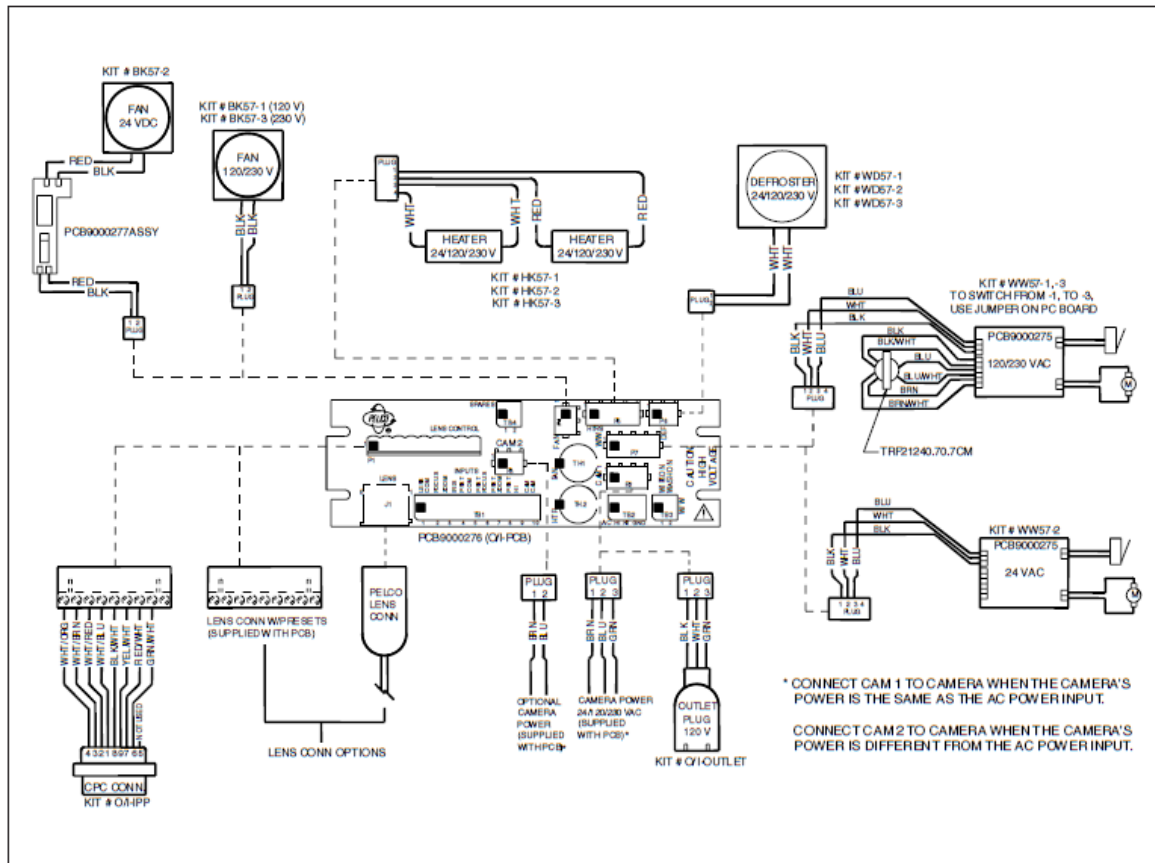

Figure 2. Enclosure Wiring Diagram

### 2.1.4 Spare Parts and Incidental Supplies

Lint free cloths and window cleaner are used to clean the outer window on the enclosure.

No other spare parts or incidental supplies are required.

## 3 CALIBRATION

Comparison of the visual boundaries and focus between the current picture and a historical picture that is known to be appropriate is the only calibration necessary.

## 4 OPERATION AND MAINTENANCE

### 4.1 Routine Operation and Maintenance

On each site visit clean the window on the outside of the enclosure.

Routinely verify the camera is functioning by viewing [www.colorado.gov/airquality/live\\_image.aspx](http://www.colorado.gov/airquality/live_image.aspx) and checking the time stamp in the top of the frame.

## 5 TROUBLESHOOTING

The camera is largely an autonomous entity that requires little intervention. However, settings in the software have become corrupt in the past, and if the camera itself is faulting a replacement is likely the best approach. Against this, settings for the current camera are shown in the screen shots below.

Access to the camera can be obtained in any web browser at 63.228.66.98:9000. The user name and password are both “admin”.

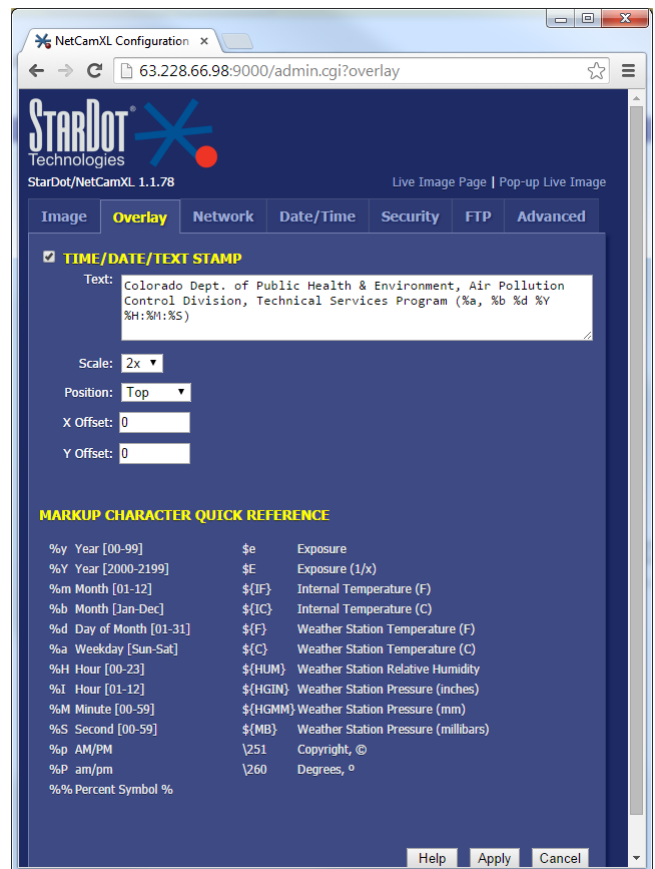
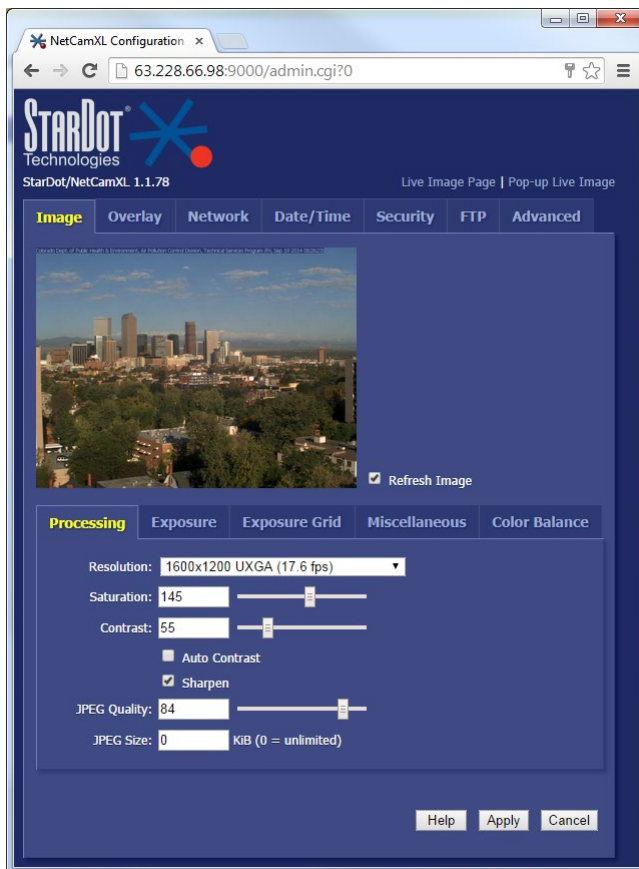

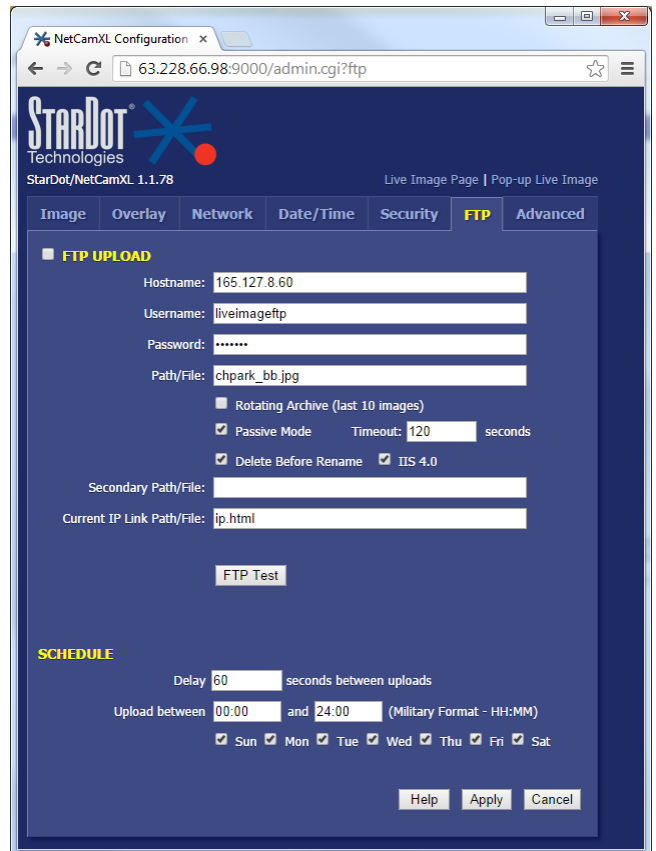
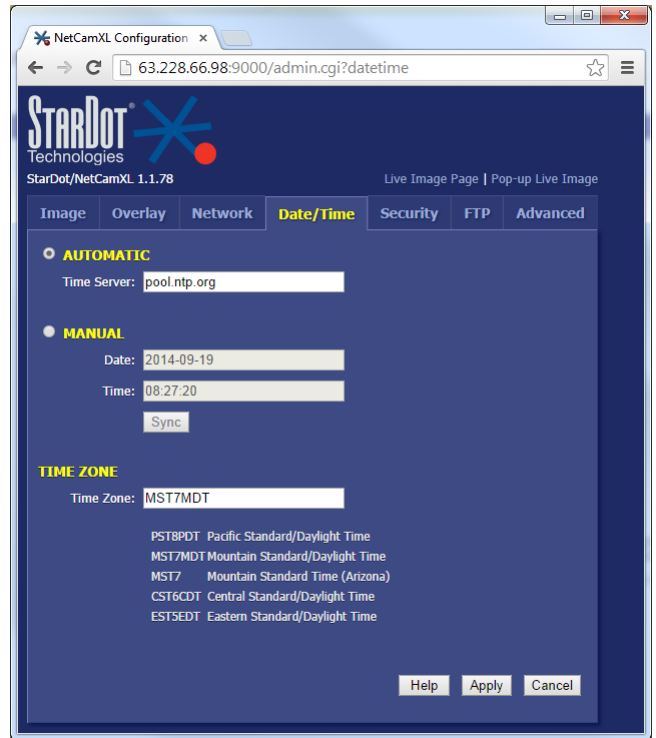
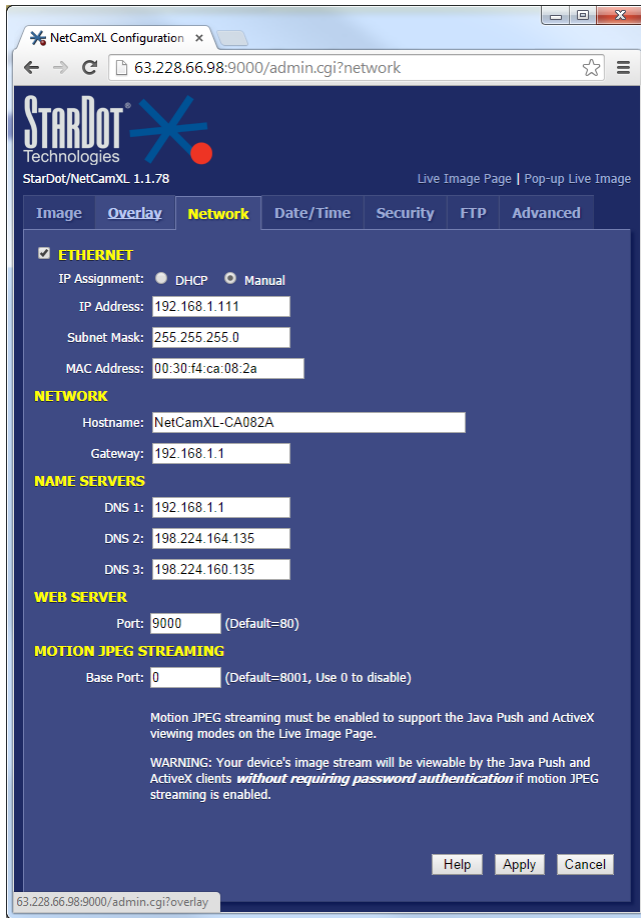



## 6 DATA ACQUISITION

The camera is connected to a modem with third-party service to the internet with a dedicated static IP address. Data is captured by the APCD every two to three minutes by a script over HTTP, as part of the configuration in Section 5.

Every hour pictures are compiled or updated into a time lapse video available at [http://www.colorado.gov/airquality/live\\_image\\_tl.aspx](http://www.colorado.gov/airquality/live_image_tl.aspx). Pictures gathered at the top of the hour (one per hour) are archived and available at [http://www.colorado.gov/airquality/live\\_image.aspx](http://www.colorado.gov/airquality/live_image.aspx) by changing the Date/Time: property below the picture.

## 7 WORKS CITED

Pelco. (n.d.). *Pelco Camera Solutions - EH5700 - Documents*. Retrieved 11 05, 2014, from Pelco: [http://www.pelco.com/sites/global/en/products/camera-solutions/range-presentation.page?c\\_filepath=/templatedata/Offer\\_Presentation/3\\_Range\\_Datasheet/data/en/shared/cameras/eh5700.xml#](http://www.pelco.com/sites/global/en/products/camera-solutions/range-presentation.page?c_filepath=/templatedata/Offer_Presentation/3_Range_Datasheet/data/en/shared/cameras/eh5700.xml#)

Stardot-Tech. (n.d.). *StarDot Knowledge Base - Netcam XL User Manual*. Retrieved 11 5, 2014, from Stardot-Tech: <http://www.stardot-tech.com/kb/index.php?View=download&EntryID=50>

US EPA. (2007). *Guidance for Preparing Standard Operating Procedures*. Research Triangle Park, NC: US EPA OAQPS AQAD.